

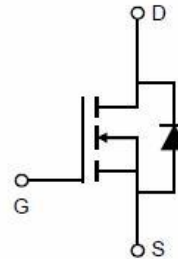

N-Channel Enhancement Mode Power MOSFET

Description

The MXN4015 uses advanced trench technology to provide excellent $R_{DS(ON)}$ and low gate charge. This device can be used for a variety of applications



General Features

- ◆ $V_{DS} = 40V$, $I_D = 35A$
- ◆ @ $V_{GS} = 10V$ $R_{DS(ON)}$ (Typ.)=7.4m Ω
- ◆ @ $V_{GS} = 4.5V$ $R_{DS(ON)}$ (Typ.)=10m Ω

High power and current handling capability
Lead free product is acquired
Surface mount package

Schematic diagram

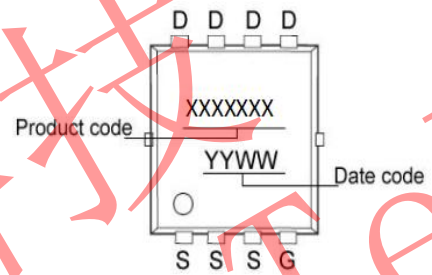

Marking and pin assignment

Application

PWM applications
Load switch
Power management

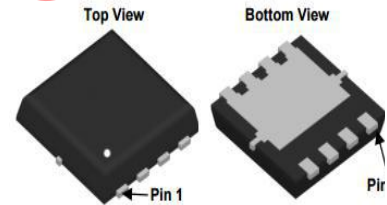

PDFN3X3-8L

Absolute Maximum Ratings (TA=25°C unless otherwise noted)

Parameter	Symbol	Limit	Unit
Drain-Source Voltage	V_{DS}	40	V
Gate-Source Voltage	V_{GS}	± 20	V
Drain Current-Continuous ($T_C = 25^\circ C$)	I_D	35	A
Drain Current-Continuous ($T_A = 25^\circ C$)	I_{DSM}	15	A
Pulsed Drain Current (Note 1)	I_{DM}	110	A
Maximum Power Dissipation	P_D	3.1	W
Operating Junction and Storage Temperature Range	T_J, T_{STG}	-55 To 150	$^\circ C$



Thermal Characteristic

Thermal Resistance, Junction-to-Ambient (Note 2)	$R_{\theta JA}$	40	$^{\circ}C/W$
--	-----------------	----	---------------

Electrical Characteristics ($T_A=25^{\circ}C$ unless otherwise noted)

Parameter	Symbol	Condition	Min	Typ	Max	Unit
Off Characteristics						
Drain-Source Breakdown Voltage	BV_{DSS}	$V_{GS}=0V, I_D=250\mu A$	40	-	-	V
Zero Gate Voltage Drain Current	I_{DSS}	$V_{DS}=40V, V_{GS}=0V$	-	-	1	μA
Gate-Body Leakage Current	I_{GSS}	$V_{GS}=\pm 20V, V_{DS}=0V$	-	-	± 100	nA
On Characteristics (Note 3)						
Gate Threshold Voltage	$V_{GS(th)}$	$V_{DS}=V_{GS}, I_D=250\mu A$	1	1.5	3	V
Drain-Source On-State Resistance	$R_{DS(on)}$	$V_{GS}=10V, I_D=12A$	-	7.4	9	m Ω
		$V_{GS}=4.5V, I_D=11A$	-	10	12.5	m Ω
Forward Transconductance	g_{FS}	$V_{DS}=5V, I_D=15A$	-	64	-	S
Dynamic Characteristics (Note 4)						
Input Capacitance	C_{iss}	$V_{DS}=25V, V_{GS}=0V,$ $F=1.0MHz$	-	1820	-	PF
Output Capacitance	C_{oss}		-	510	-	PF
Reverse Transfer Capacitance	C_{rss}		-	40	-	PF
Switching Characteristics (Note 4)						
Turn-on Delay Time	$t_{d(on)}$	$V_{DS}=20V, R_L=0.75\Omega$	-	7.2	-	nS
Turn-on Rise Time	t_r		-	3	-	nS
Turn-Off Delay Time	$t_{d(off)}$	$V_{GS}=10V, R_{GEN}=3\Omega$	-	23	-	nS
Turn-Off Fall Time	t_f		-	3.5	-	nS
Total Gate Charge	Q_g	$V_{DS}=25V, I_D=15A,$ $V_{GS}=10V$	-	26	-	nC
Gate-Source Charge	Q_{gs}		-	4	-	nC
Gate-Drain Charge	Q_{gd}		-	6	-	nC
Drain-Source Diode Characteristics						
Diode Forward Voltage (Note 3)	V_{SD}	$V_{GS}=0V, I_S=20A$	-	-	1.2	V

Notes:

- 1.Repetitive Rating: Pulse width limited by maximum junction temperature.
- 2.Surface Mounted on FR4 Board, $t \leq 10$ sec.
- 3.Pulse Test: Pulse Width $\leq 300\mu s$, Duty Cycle $\leq 2\%$.
4. Guaranteed by design, not subject to production

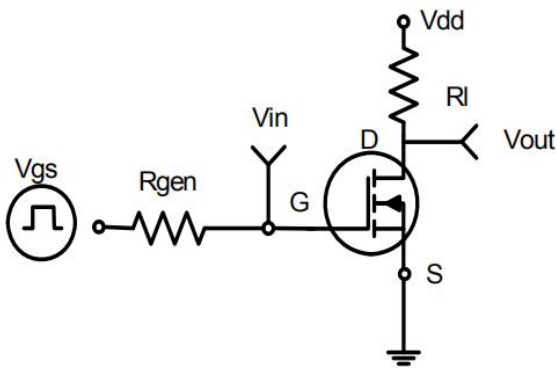

Figure 1: Switching Test Circuit

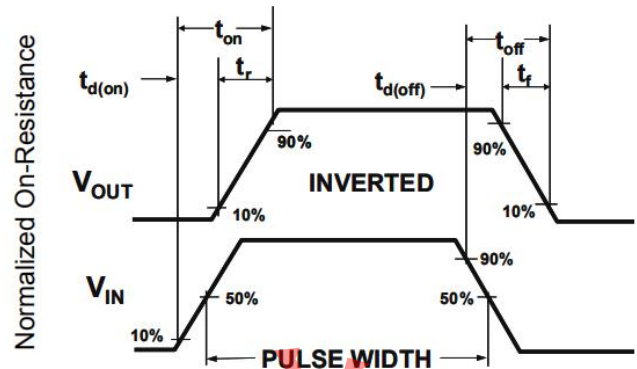

Figure 2: Switching Waveforms

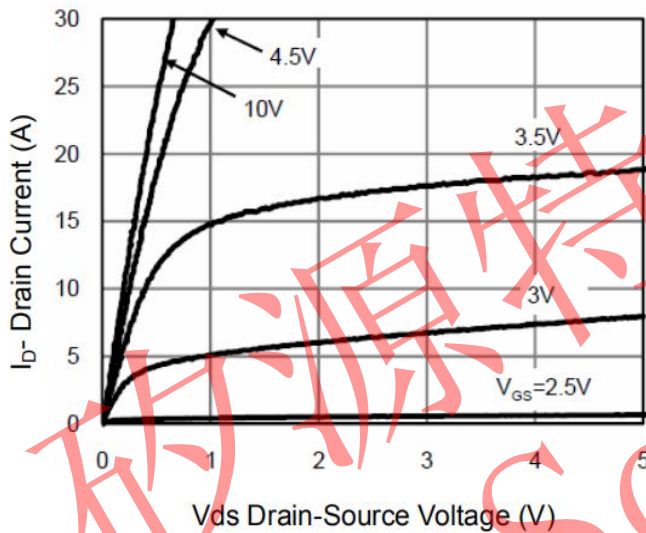

Figure 3 Output Characteristics

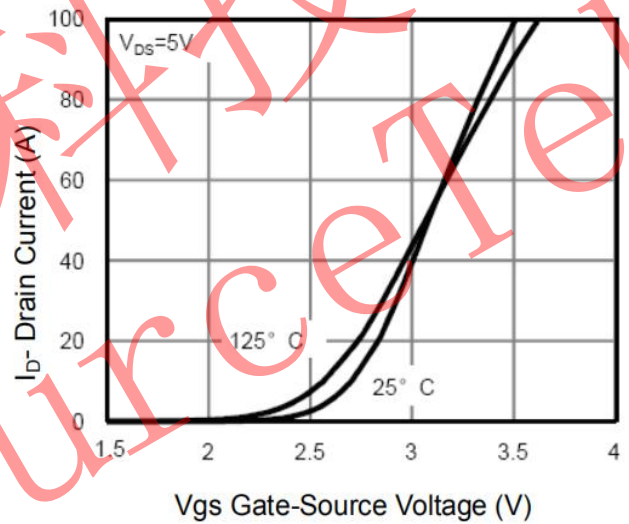

Figure 4 Transfer Characteristics

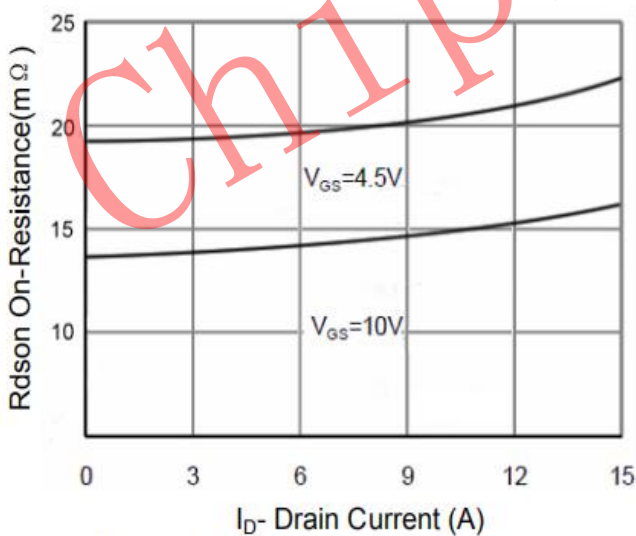

Figure 5 Drain-Source On-Resistance

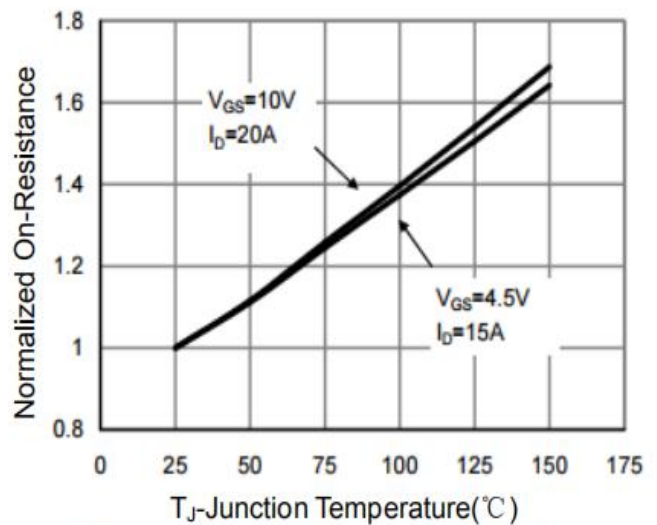
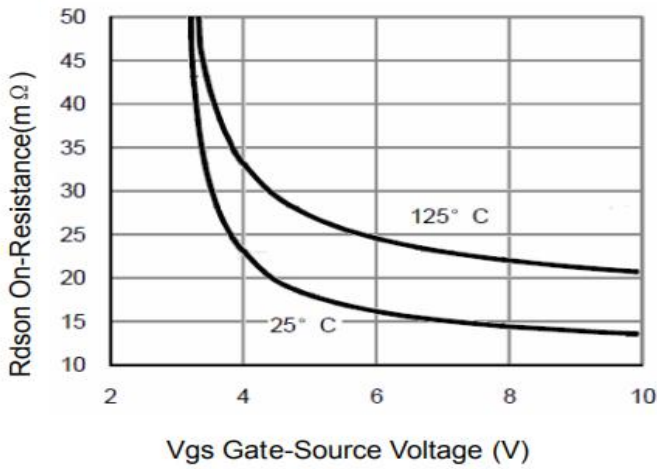
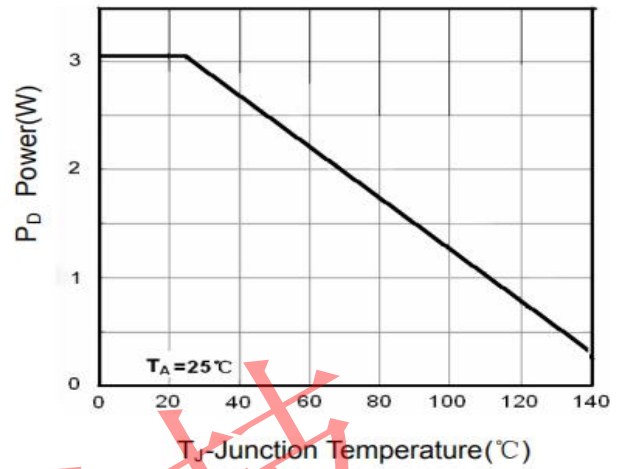

Figure 6 Drain-Source On-Resistance



Vgs Gate-Source Voltage (V)
Figure 7 Rdson vs Vgs



Tj Junction Temperature (°C)
Figure 8 Power Dissipation

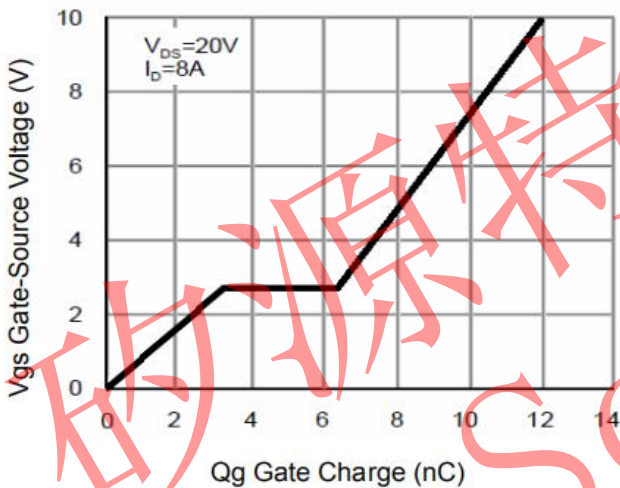

Figure 9 Gate Charge

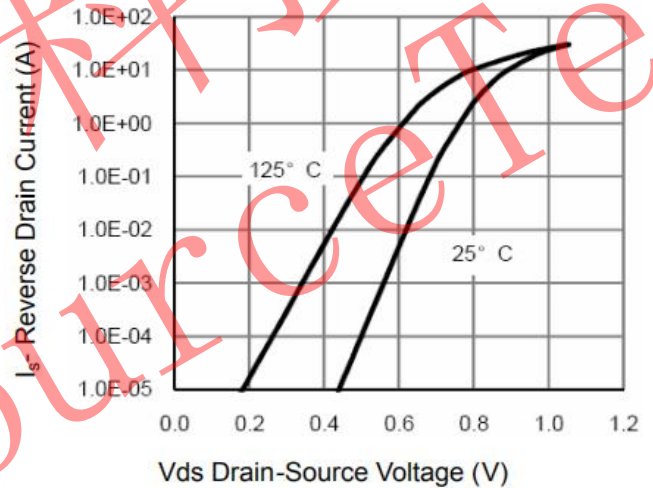
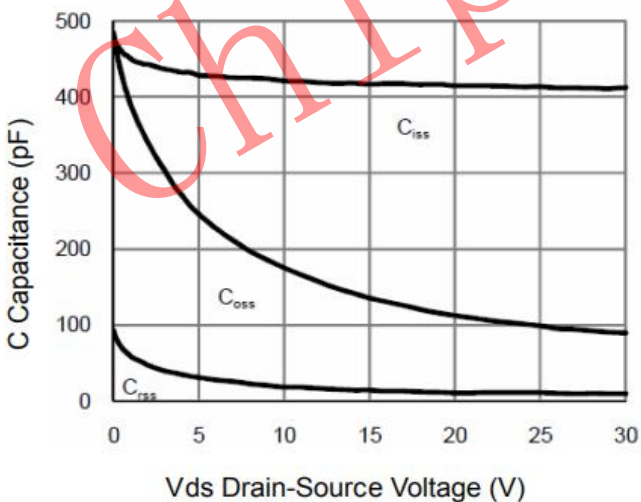

Figure 10 Source- Drain Diode Forward



Vds Drain-Source Voltage (V)
Figure 11 Capacitance vs Vds

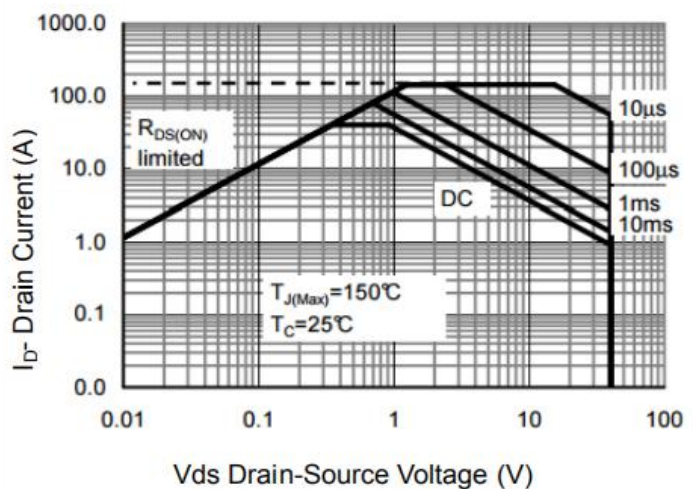

Figure 12 Safe Operation Area

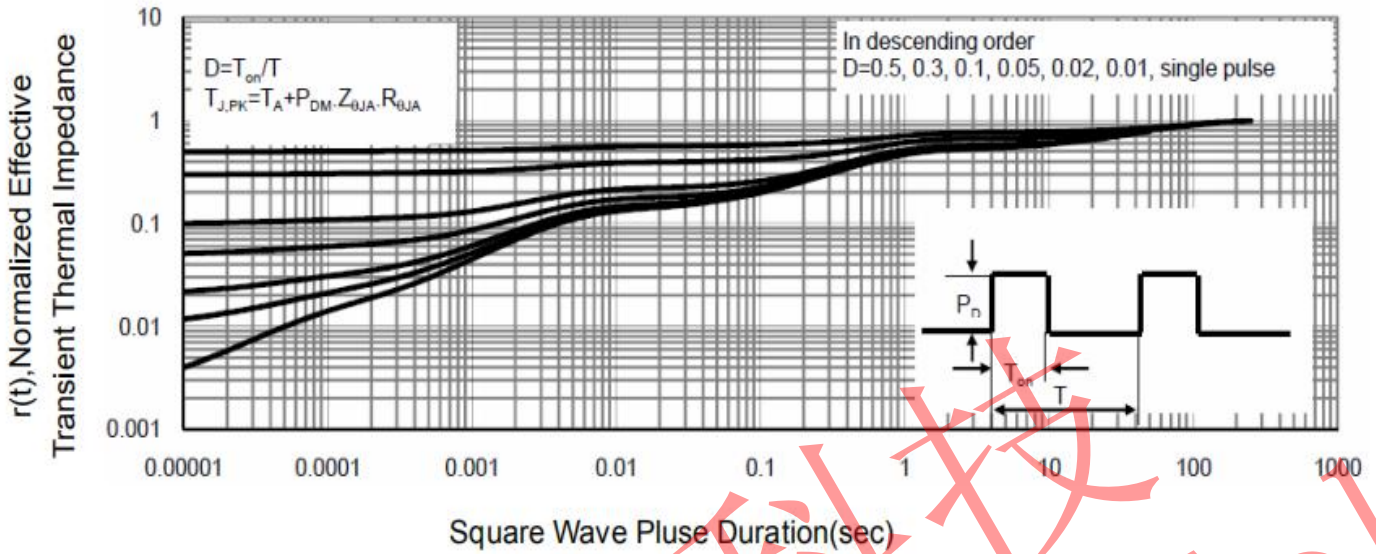
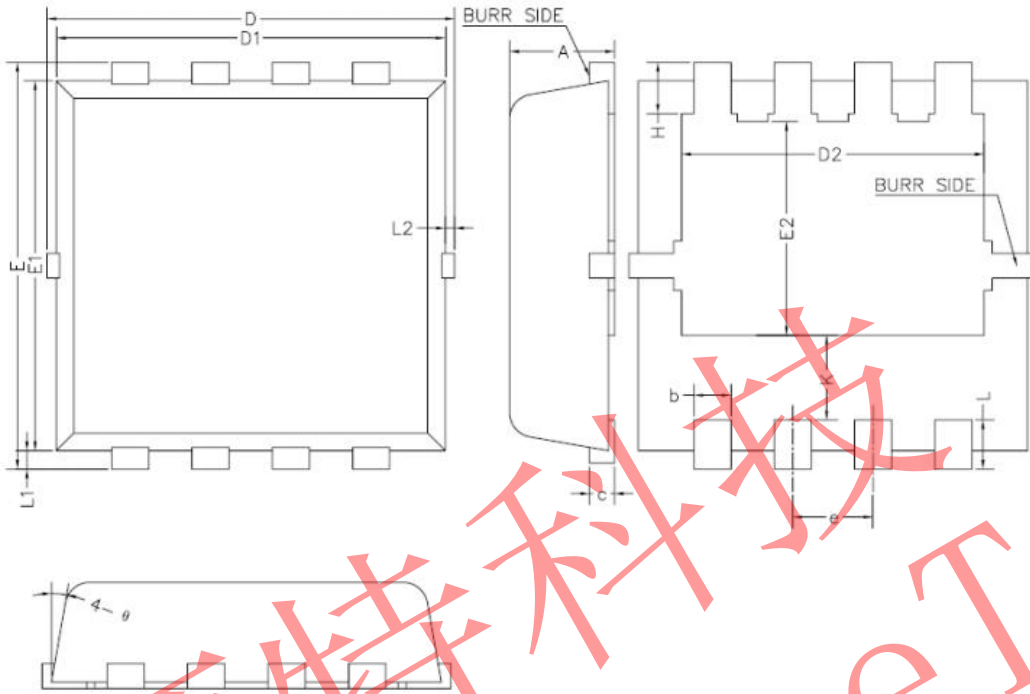

Figure 13 Normalized Maximum Transient Thermal Impedance



PDFN3x3-8L PACKAGE



COMMON DIMENSIONS
(UNITS OF MEASURE=MILLIMETER)

SYMBOL	MIN	NOM	MAX
A	0.70	0.80	0.90
b	0.25	0.30	0.35
c	0.14	0.15	0.20
D	3.10	3.30	3.50
D1	3.05	3.15	3.25
D2	2.35	2.45	2.55
e	0.55	0.65	0.75
E	3.10	3.30	3.50
E1	2.90	3.00	3.10
E2	1.64	1.74	1.84
H	0.32	0.42	0.52
K	0.59	0.69	0.79
L	0.25	0.40	0.55
L1	0.10	0.15	0.20
L2	—	—	0.15
θ	8°	10°	12°